

**Main ratings**

Drain-source voltage  $V_{DS} = 500\text{ V}$   
 Continuous drain current  $I_D = 9,5\text{ A}$   
 Drain-source on-resistance  $R_{DS(on)} = 0,6\ \Omega$

N-Channel

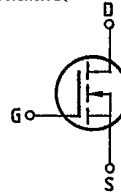

**Description** SIPMOS, N-channel, enhancement mode  
**Case** Plastic package 15 in accordance with DIN 41869 or TO 218 AA (TOP 3) in accordance with JEDEC.  
 The drain terminal is conductively connected to the mounting flange.  
 Approx. weight 4,5 g

Type	Ordering code
BUZ 353	C67078-A3104-A2

Not for new design

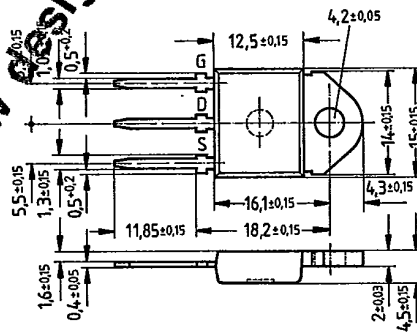

Dimensions in mm

**Maximum ratings**

Description	Symbols	Ratings	Units	Conditions
Drain-source voltage	$V_{DS}$	500	V	
Drain-gate voltage	$V_{DGR}$	500	V	$R_{GS} = 20\text{ k}\Omega$
Continuous drain current	$I_D$	9,5	A	$T_C = 30\text{ }^\circ\text{C}$
Pulsed drain current	$I_{Dpuls}$	38	A	$T_C = 25\text{ }^\circ\text{C}$
Gate-source voltage	$V_{GS}$	$\pm 20$	V	
Max. power dissipation	$P_D$	125	W	$T_C = 25\text{ }^\circ\text{C}$
Operating and storage temperature range	$T_J$ $T_{stg}$	$-55 \dots +150$	$^\circ\text{C}$	
DIN humidity category	E			DIN 40 040
IEC climatic category	55/150/56			DIN IEC 68-1

**Thermal resistance**

Chip - case	$R_{th\text{JC}}$	$\leq 1,0$	K/W
Chip - ambient	$R_{th\text{JA}}$	$\leq 45$	K/W

742  Preferred Type

1324

D-03

**Electrical characteristics**(at  $T_j = 25^\circ\text{C}$  unless otherwise specified)

Description	Symbol	Characteristics			Unit	Conditions
		min.	typ.	max.		

**Static ratings**

Drain-source breakdown voltage	$V_{(BR)DSS}$	500	—	—	V	$V_{GS} = 0V$ $I_D = 0,25mA$
Gate threshold voltage	$V_{GS(th)}$	2,1	3,0	4,0		$V_{DS} = V_{GS}$ $I_D = 1mA$
Zero gate voltage drain current	$I_{DSS}$	—	20	250	$\mu A$	$T_j = 25^\circ\text{C}$ $T_j = 125^\circ\text{C}$ $V_{DS} = 500V$ $V_{GS} = 0V$
Gate-source leakage current	$I_{GSS}$	—	10	100	nA	$V_{GS} = 20V$ $V_{DS} = 0V$
Drain-source on-resistance	$R_{DS(on)}$	—	0,55	0,6	$\Omega$	$V_{GS} = 10V$ $I_D = 5,5A$

**Dynamic ratings**

Forward transconductance	$g_{fs}$	2,7	5,0	—	S	$V_{DS} = 25V$ $I_D = 5,5A$
Input capacitance	$C_{iss}$	—	3,8	4,9	nF	$V_{GS} = 0V$
Output capacitance	$C_{oss}$	—	250	400	pF	$V_{DS} = 25V$ $f = 1MHz$
Reverse transfer capacitance	$C_{rss}$	—	100	170		
Turn-on time $t_{on}$ ( $t_{on} = t_{d(on)} + t_r$ )	$t_{d(on)}$	—	50	75	ns	$V_{CC} = 30V$ $I_D = 2,8A$ $V_{GS} = 10V$ $R_{GS} = 50\Omega$
	$t_r$	—	80	120		
Turn-off time $t_{off}$ ( $t_{off} = t_{d(off)} + t_f$ )	$t_{d(off)}$	—	330	430		
	$t_f$	—	110	140		

**Reverse diode**

Continuous reverse drain current	$I_{DR}$	—	—	9,5	A	$T_C = 25^\circ\text{C}$
Pulsed reverse drain current	$I_{DRM}$	—	—	38		
Diode forward on-voltage	$V_{SD}$	—	1,3	1,7	V	$I_F = 2 \times I_{DR}$ $V_{GS} = 0V, T_j = 25^\circ\text{C}$
Reverse recovery time	$t_{rr}$	—	1,2	—	$\mu s$	$T_j = 25^\circ\text{C}$
Reverse recovery charge	$Q_{rr}$	—	12	—	$\mu C$	$I_F = I_{DR}$ $d_F/dt = 100A/\mu s$ $V_R = 100V$

Power dissipation  $P_D = f(T_C)$

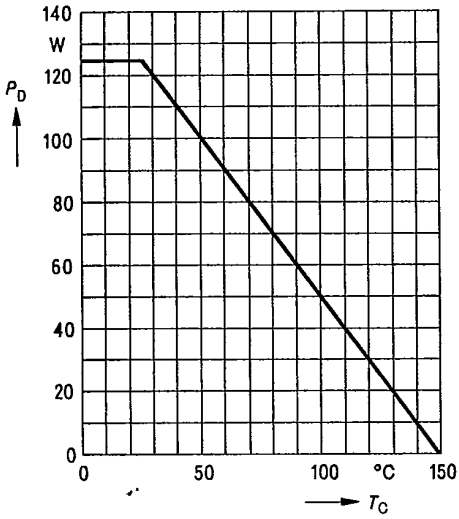

Typical output characteristics  $I_D = f(V_{DS})$   
parameter: 80  $\mu$ s pulse test,  
 $T_J = 25^\circ\text{C}$

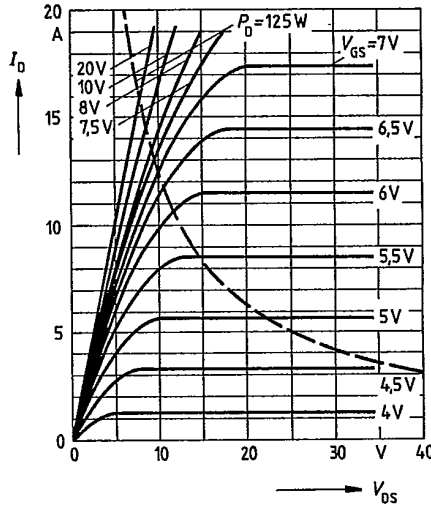

Safe operating area  $I_D = f(V_{DS})$   
parameter:  $D = 0.01$ ,  $T_C = 25^\circ\text{C}$

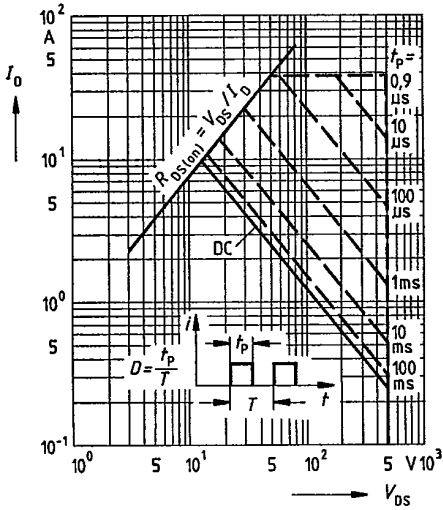

Typical transfer characteristic  $I_D = f(V_{GS})$   
parameter: 80  $\mu$ s pulse test,  
 $V_{DS} = 25\text{V}$ ,  $T_J = 25^\circ\text{C}$

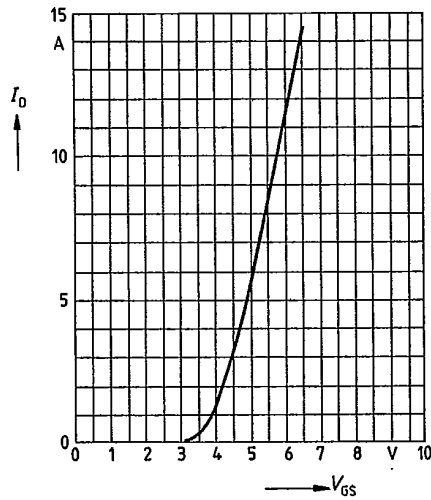

**Typical drain-source on-state resistance**

$R_{DS(on)} = f(I_D)$   
parameter:  $V_{GS}$ ;  $T_j = 25^\circ\text{C}$

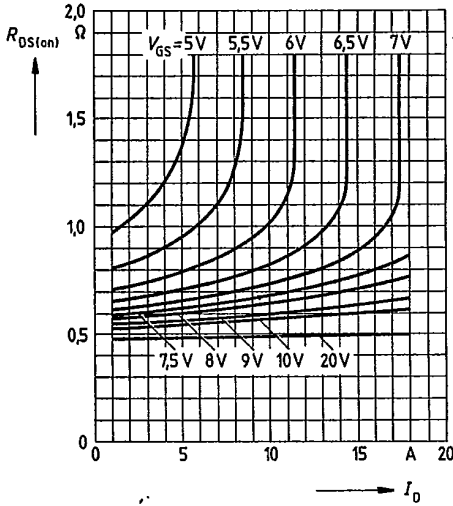

**Drain-source on-state resistance**

$R_{DS(on)} = f(T_j)$   
parameter:  $I_D = 5.5\text{A}$ ,  $V_{GS} = 10\text{V}$   
(spread)

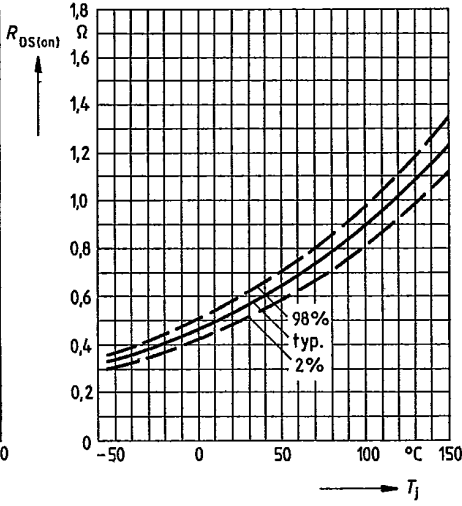

**Typical transconductance  $g_{fs} = f(I_D)$**

parameter: 80  $\mu\text{s}$  pulse test,  
 $V_{DS} = 26\text{V}$ ,  $T_j = 25^\circ\text{C}$

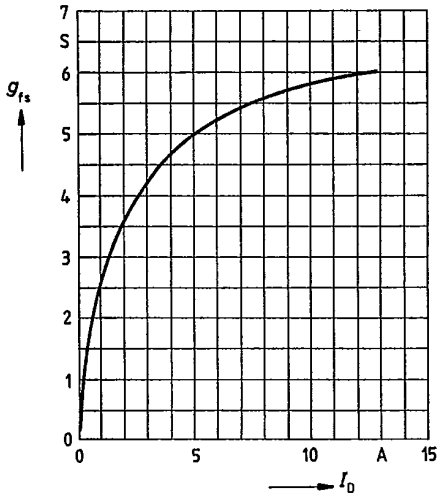

**Gate threshold voltage  $V_{GS(th)} = f(T_j)$**

parameter:  $V_{DS} = V_{GS}$ ,  $I_D = 1\text{mA}$   
(spread)

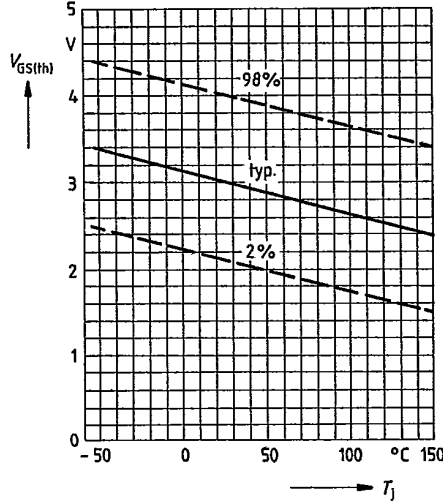

**Typical capacitances  $C = f(V_{DS})$**   
parameter:  $V_{GS} = 0, f = 1\text{MHz}$

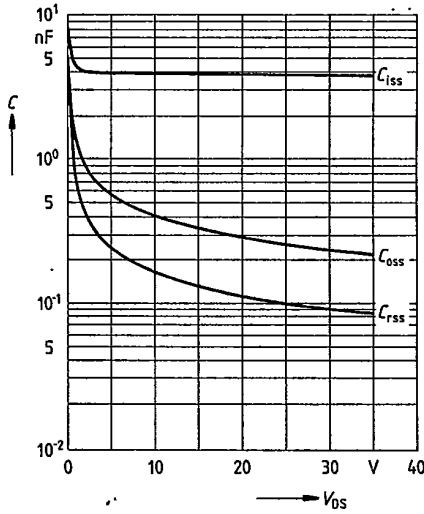

**Continuous drain current  $I_D = f(T_C)$**   
parameter:  $V_{GS} \geq 10\text{V}$

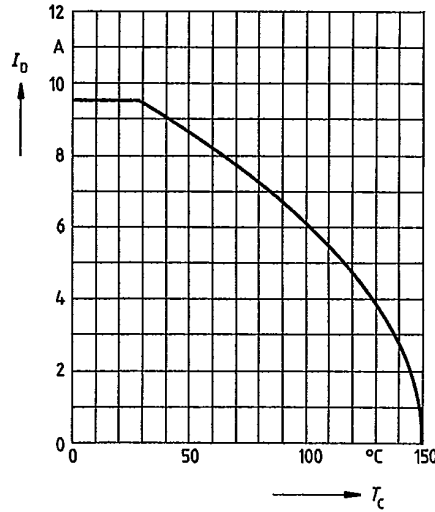

**Forward characteristic of reverse diode**  
 $I_F = f(V_{SD})$   
parameter:  $T_j, t_p = 80 \mu\text{s}$   
(spread)

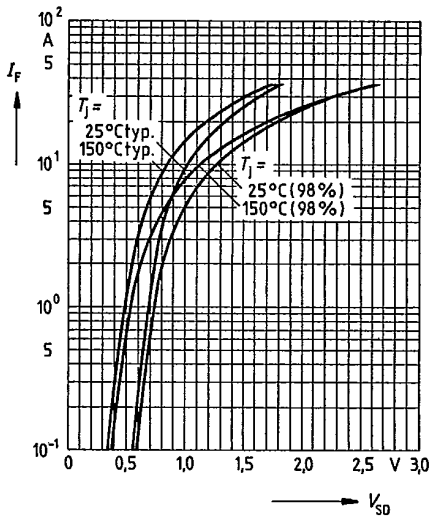

746

1328

0-07

Transient thermal impedance  $Z_{thJC} = f(t)$   
 parameter:  $D = t_p/T$

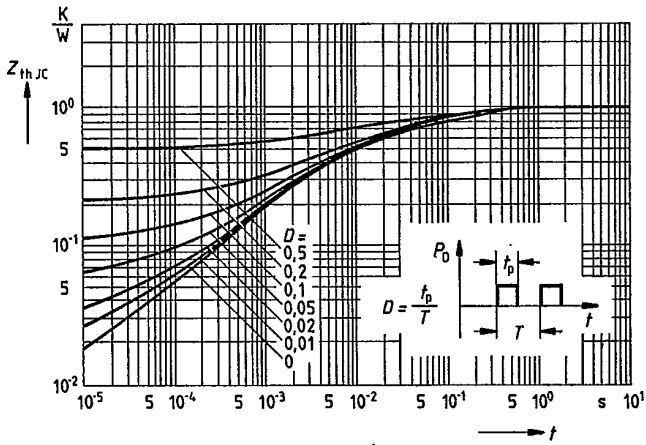

Typical gate-charge  $V_{GS} = f(Q_{Gate})$   
 parameter:  $I_{D\ pulse} = 14.4A$

